

Modellname:
Nazwa modelu:

DOVER

Modellreihe:
Numer modelu:

SL -- 08

Type: **14**
Typ:

Blatt Nr **1** von: **5**
Strona z:

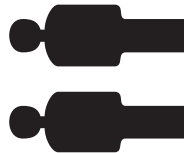

2 Personen
2 Osoby

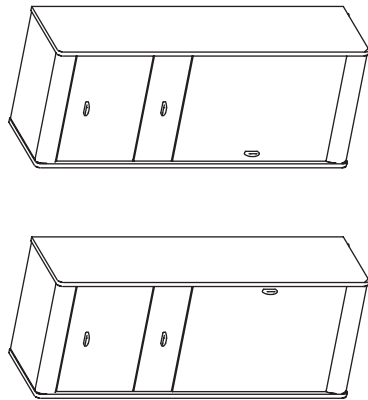
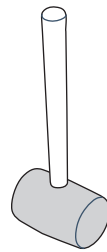
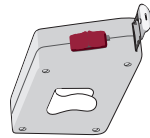

TYPE "L"

TYPE "R"

**MONTOWAĆ
NA ROZŁOŻONYM KARTONIE!**

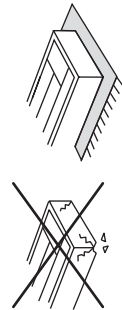

**Wskazówka dotycząca
pielęgnacji!**

Proszę czyścić tylko suchą
lub lekko wilgotną szmatką do kurzu.
Nie używać żadnych środków szorstkich!
Maksymalne obciążenie półek w kg:

Stärke/Gr. / Spanplatte/Płyta	15	18	22
Länge/Dł. /mm	40	40	40
0<400	24	15	30
401<600			
601<800			
801<1000			

MONTAGEANLEITUNG INSTRUKCJA MONTAŻOWA

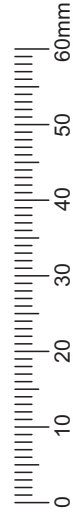
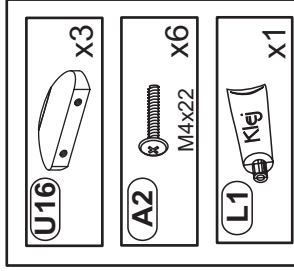
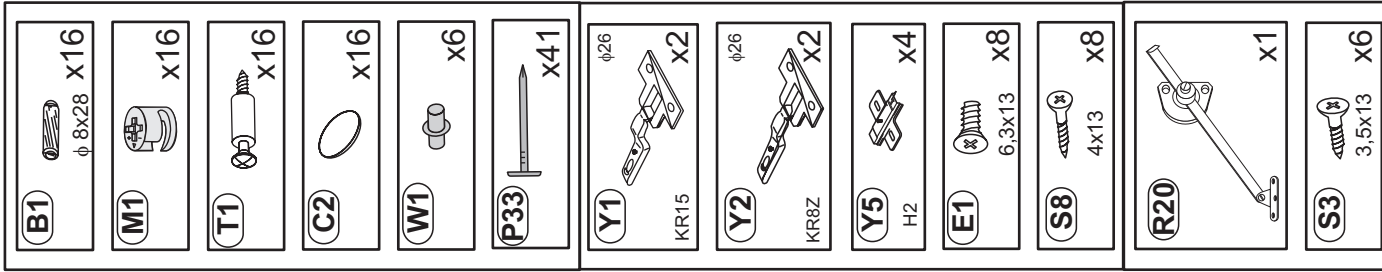
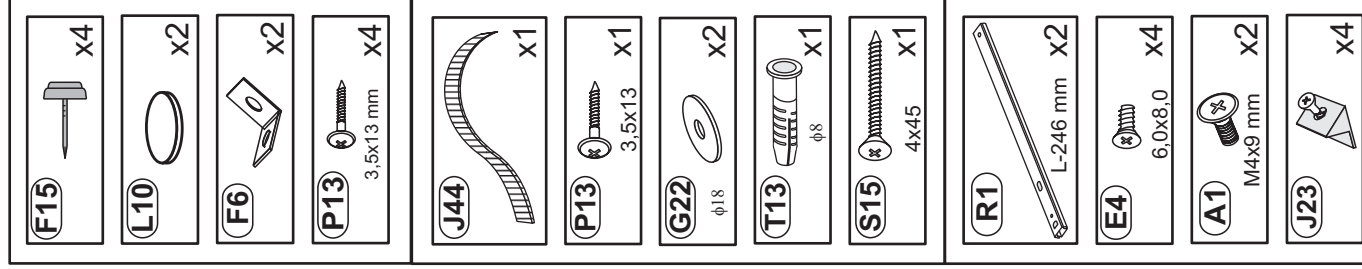
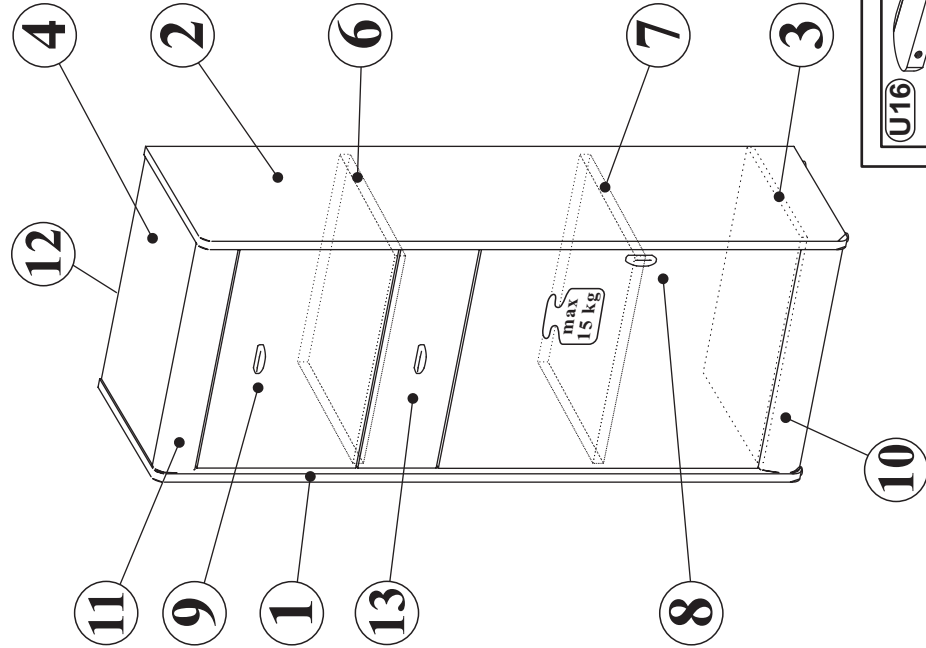

Modellname:
Nazwa modelu:

DOVER

Modellreihe:
Numer modelu:

SL -- 08

Type: **14**
Typ:

Blatt Nr **2**
Strona

von: **5**
z:

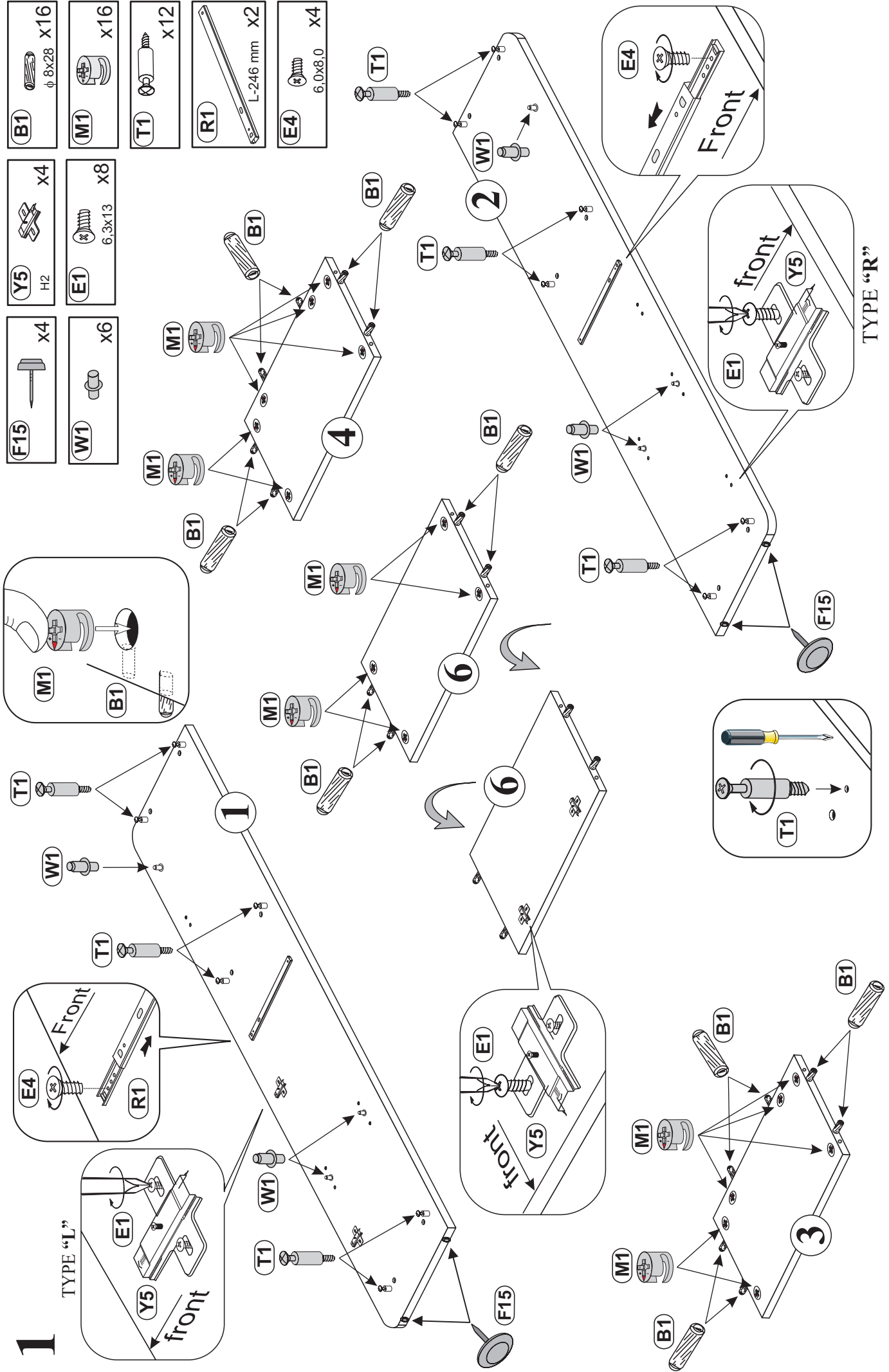

B1 $\phi 8 \times 28$ x16

M1 x16

T1 x12

R1 L-246 mm x2

E4 6,0x8,0 x4

Y5 H2 x4

E1 6,3x13 x8

F15 x4

W1 x6

M1 **B1**

E4 **R1** Front

Y5 **E1** front

E1 **Y5** front

T1

E1 **Y5** front

TYPE "R"

Modellname:
Nazwa modelu:

DOVER

Modellreihe:
Numer modelu:

SL -- 08

Type: **14**
Typ:

Blatt Nr **3** von: **5**
Strona z:

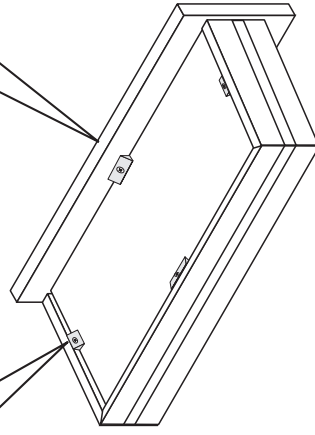
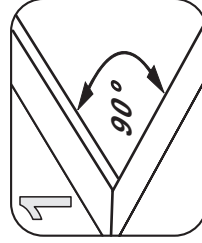
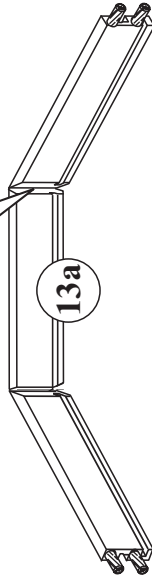
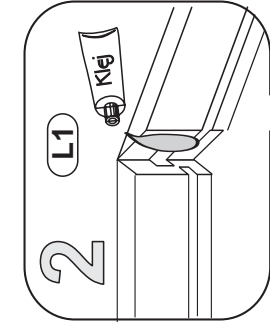
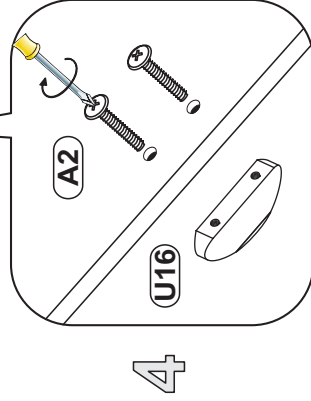
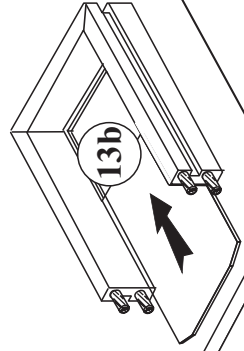
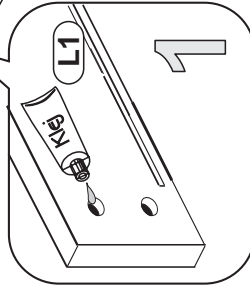
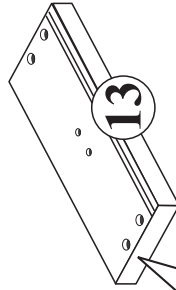
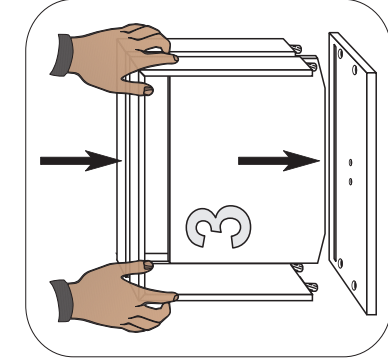
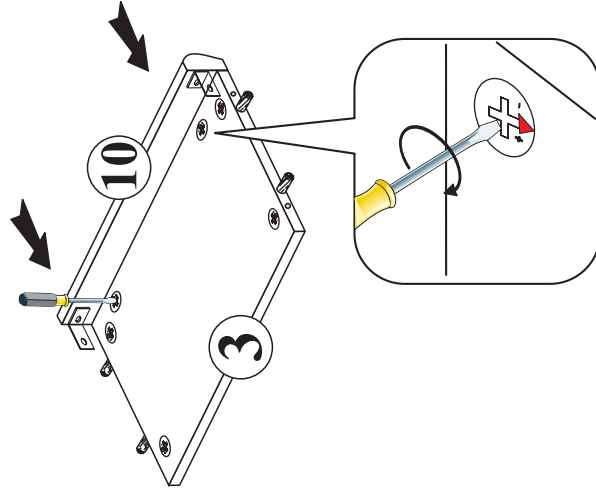
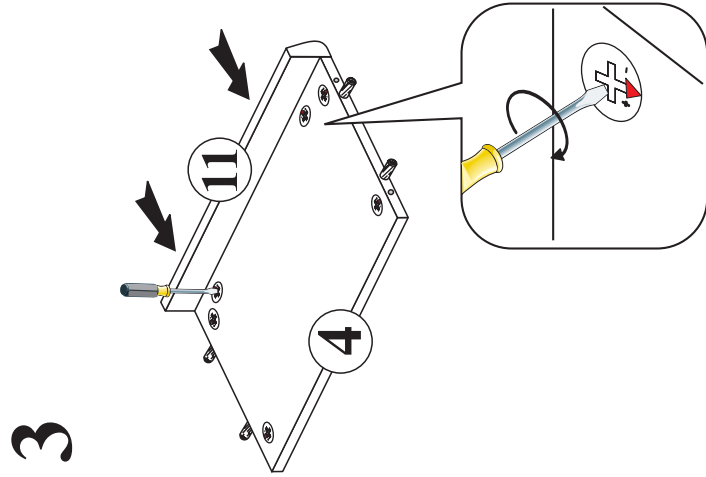
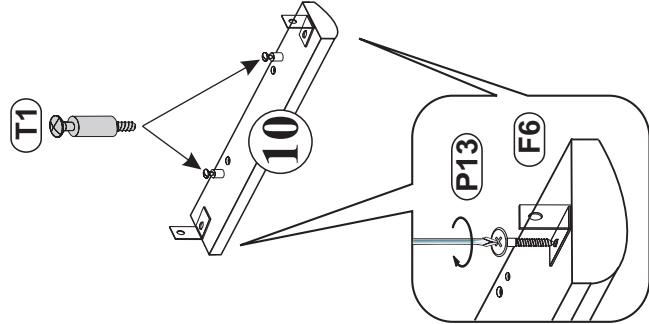
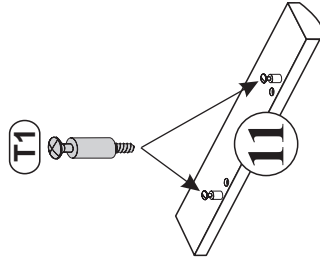
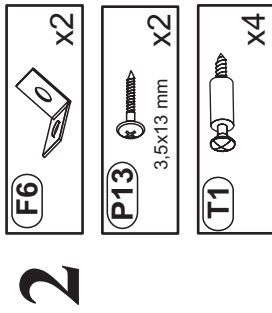

Modellname:
Nazwa modelu:

DOVER

Modellreihe:
Numer modelu:

SL -- 08

Type:
Typ:

14

Blatt Nr
Strona

4 von: 5
z:

6

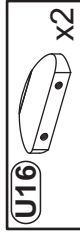

x2



x4



x2

KR15



x8

4x13



x2

KR8Z



x2

φ26

7

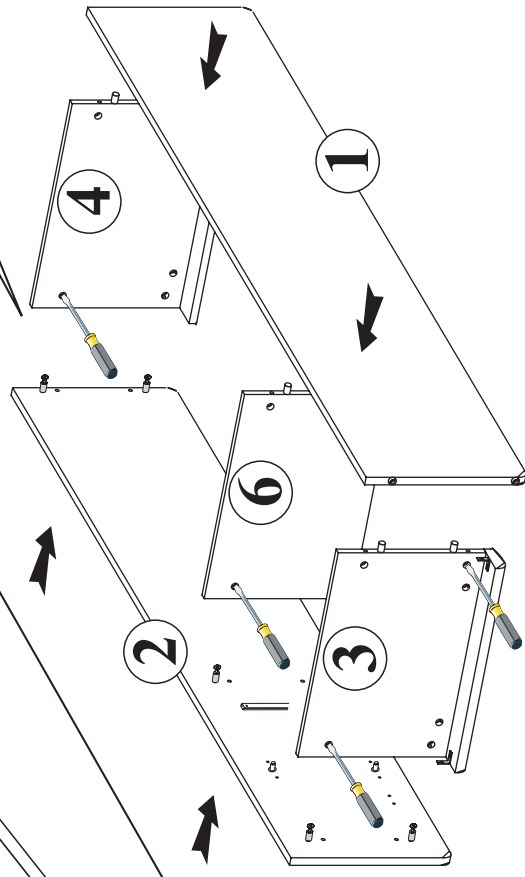
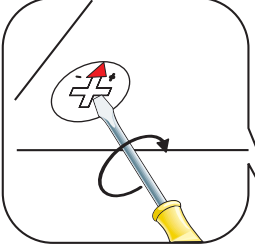
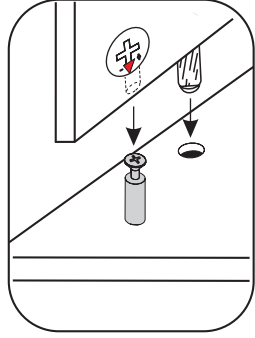

8

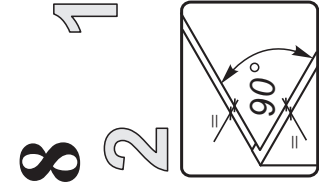

2

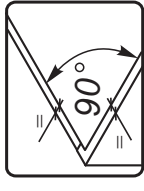

12

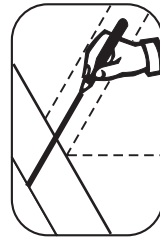

1



x2

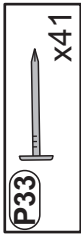

x41

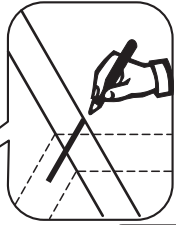
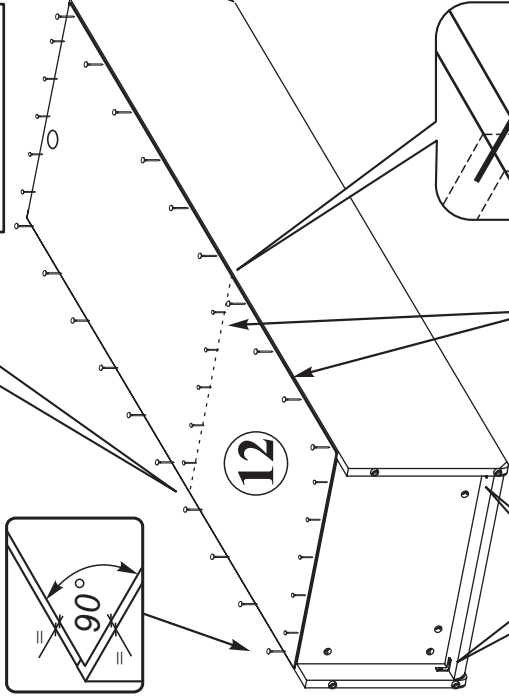

1

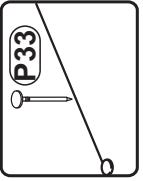

3

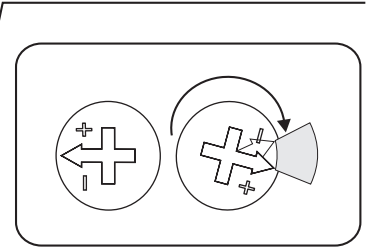
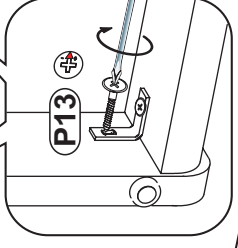

9

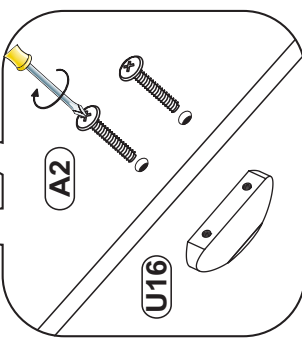
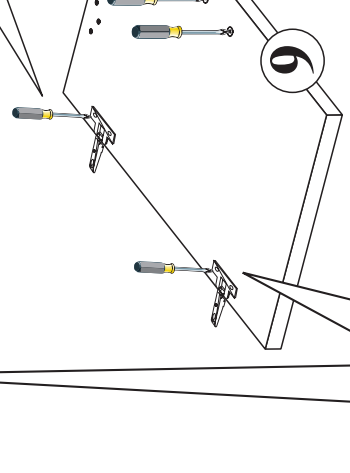
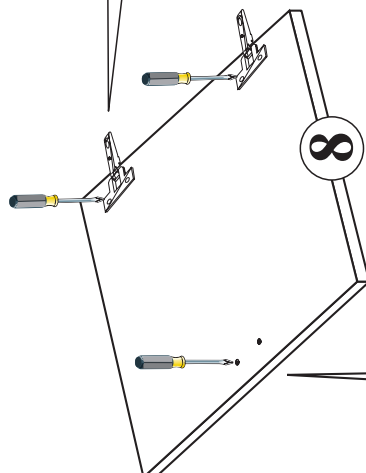

A2

U16

Modellname:
Nazwa modelu:

DOVER

Modellreihe:
Numer modelu:

SL -- 08

Type:
Typ:

14

Blatt Nr
Strona

von: **5**
z: **5**

9

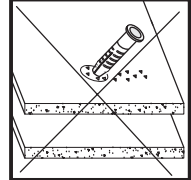
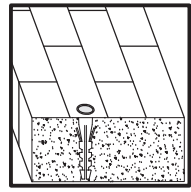
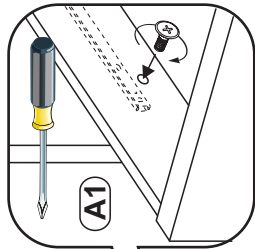
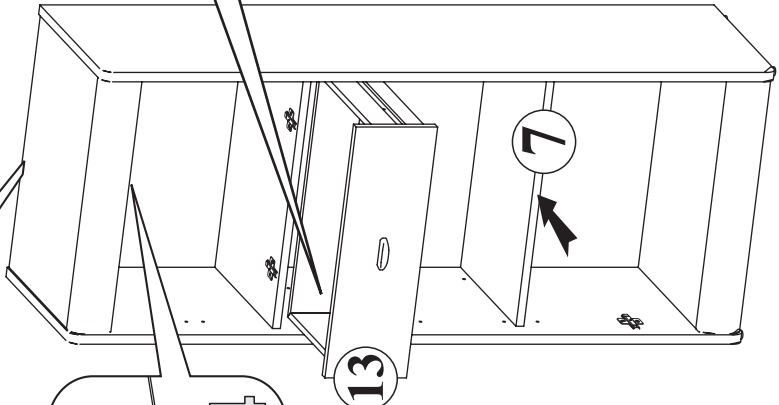
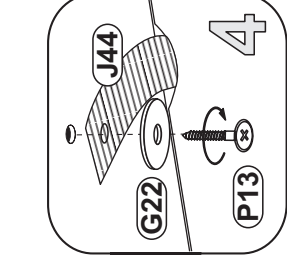
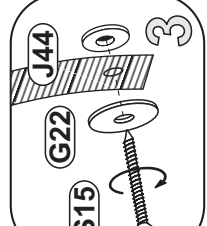
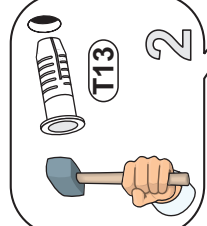
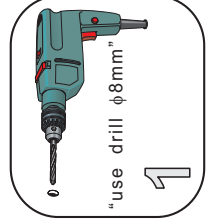
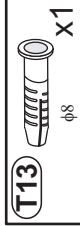

10

